

Date _____
 AVFI Sales REP _____
 Customer Signature _____

Quote No. _____
 Customer No. _____
 AVFI No. _____

Office Use Only

To generate your order form, please refer to the information provided below to insert the alphabetic and/or numeric code in the respective category boxes. Please note that without this filled out Order Form, your purchase **cannot** be processed.

| 1 Product Model | 2 Finish | 3 Chargeable Accessories | 4 Custom Cutouts |
|---|----------|--------------------------|------------------|
| Please fill selection MOD#- _____ | | | |

1 Product Model



MOD2945-D
Seat Height





MOD3745-M
Counter Height

2 Choose Product Finish

Standard Finishes (Ships within 1-15 business days)



MCT

HCT



CLT



AST



AMT



SBT

WLT

SST

EBT

SGT

CWT

3 Chargeable Add-ons (Check all that apply)

| | |
|--|------|
| Code 0 No Accessories | |
| Code X1 MOD29-A Series 10U Rack 20" Depth - A Top | Qty: |
| Code X2 MOD29-A EXT Series 10U Rack 23" Depth - A Top | Qty: |
| Code X3 MOD29-B Series 10U Rack 20" Depth - B Top | Qty: |
| Code X4 MOD29-B EXT Series 10U Rack 23" Depth - B Top | Qty: |
| Code X5 MOD37-J Series 14U Rack 20" Depth - A Top | Qty: |
| Code X6 MOD37-J EXT Series 14U Rack 23" Depth - A Top | Qty: |
| Code X7 MOD37-K Series 14U Rack 20" Depth - B Top | Qty: |
| Code X8 MOD37-K EXT Series 14U Rack 23" Depth - B Top | Qty: |
| Code T1 MOD-RC Series Round Corner | Qty: |
| Code T2 MOD-SC Series Square Corner | Qty: |
| Code T3 MOD-02 Series Round Desk End | Qty: |
| Code T4 MOD-00 Series Dual Rack Desk End | Qty: |
| Code T0 MOD-LS Series Lower Shelf | Qty: |
| Code T6 MODU-P1 Modesty Panel | Qty: |

3 Chargeable Accessories (Check all that apply)

| | |
|---|------|
| * Code EF CHGQIB Wireless Charging Station Black | Qty: |
| Code K1 C900S Single Monitor Arm | Qty: |
| Code K2 C900D Dual Monitor Arm | Qty: |
| * Code P2 PCH730 PC Holder | Qty: |
| * Code K3 PLM1022 LCD Monitor Mount | Qty: |
| * Code D3 FM3 Countdown Timer and Clock | Qty: |
| * Code D2 LIGHT-18 Adjustable Gooseneck Light | Qty: |
| * Code E3 CUB3 Round Cable Well | Qty: |
| * Code E5 CUB5 Black Round Cable Well | Qty: |
| * Code E6 CUB5 Silver Round Cable Well | Qty: |
| * Code E8 CUB8 Table Top Cable Well | Qty: |
| * Code EA CUB4S Silver Power Panel | Qty: |
| * Code EB CUB4B Round Cable Well | Qty: |
| * Code EJ CUB22 Black 3 Module Panel | Qty: |
| * Code EK CUBM3 3 Module Power & Data Panel | Qty: |
| * Code EL CUBM4 4 Module Power & Data Panel | Qty: |
| * Code D1 MIC-18 Gooseneck Microphone | Qty: |
| Code M10 FWM100 VESA Mounting Bracket | Qty: |
| Code P10 50CAS Easy Maneuvering Casters | Qty: |
| Code E1 PB 6 Outlet Power Bar | Qty: |
| Code | Qty: |
| Code | Qty: |
| Code | Qty: |
| * Cutout Required (Extra Charges will apply) | |
| § Only on Flat Cutout | |

All add-on options will be provided with the same finish specified in this order form. If alternative finish or accessories are required specifically for the add-on unit, please contact our sales team or visit our website for more information.

Date _____
 AVFI Sales REP _____
 Customer Signature _____

Quote No. _____
 Customer No. _____
 AVFI No. _____

OFFICE USE ONLY

Office Use Only

Comments (Please use this section to provide additional information)

Notes

CAD Drawings/Symbols

CAD drawings are available by request at sales@vegroup.net

Custom Cutouts

Estimated lead time within 20 business days from receipt of P.O. and signed drawings.

Customizations

Modifications to design such as shape and/or size variations have to be quoted on a per case basis and are applicable for quantities of 10+ only.

Please indicate custom cutout location on the drawing(s) below

4 Custom Cutout Option (Extra charges will apply)

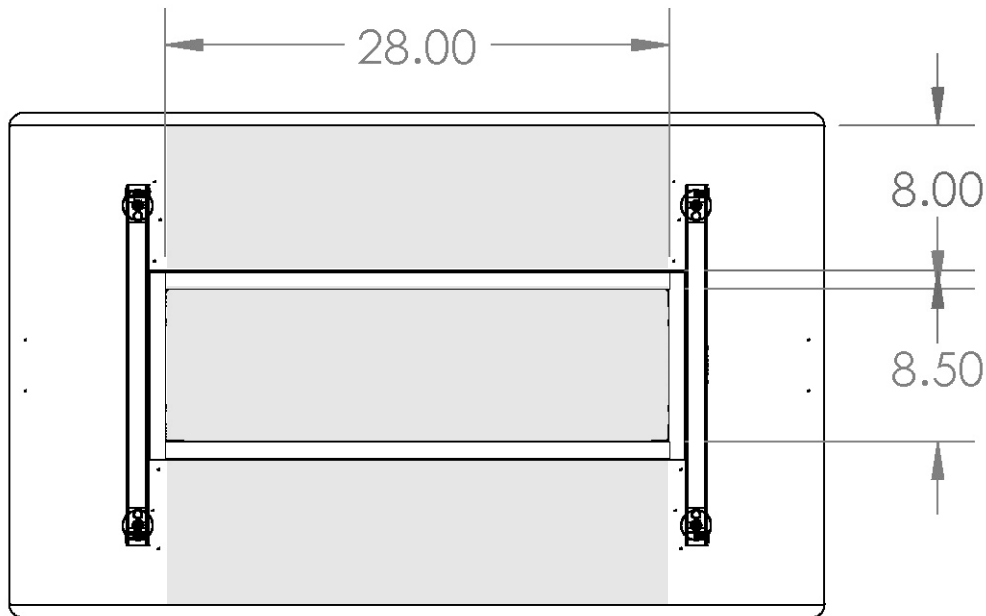

Code **CO** No Custom Cutout

Code **CC** Custom Cutout (Specify on Cutout Area Above)

■ Cutout Area - Work Surface